

- 86%
- 0.95
- IP66 UL
- Class 2 & SELV



EUV-026SxxxPS 90 ~ 305 Vac

	1			2			5
					120Vac	220Vac	
24 Vdc	90 ~ 305 Vac	0~1080 mA	26 W	84%	0.96	0.95	EUV-026S024PS ⁽³⁾
36 Vdc	90 ~ 305 Vac	0~720 mA	26 W	85%	0.96	0.95	EUV-026S036PS ⁽³⁾
48 Vdc	90 ~ 305 Vac	0~540 mA	26 W	86%	0.96	0.95	EUV-026S048PS ⁽⁴⁾

- 1 UL FCC 100-277Vac 100-240Vac
- 2 220Vac, 100%
- 3 Class 2 &
- 4 Class 2, Class 2
- 5 -00K0

	90 Vac	-	305 Vac	
	47 Hz	-	63 Hz	
	-	-	0.75 MIU	UL8750; 277Vac/60Hz
	-	-	0.70 mA	IEC60598-1; 240Vac/60Hz
	-	-	0.4 A	100Vac 100%
	-	-	0.2 A	220Vac 100%
	-	-	40 A	220Vac 25°C 10%-10% =100 s
I ² t	-	-	0.043 A ² s	

	0.90	-	-	100~277Vac,50-60Hz,75%~100% (19.5~26W)
	-	-	20%	

	-5%Vo		5%Vo	
Vo = 24 V Vo = 36 V Vo = 48 V	- - -	- - -	3 V 4 V 4 V	20MHz 0.1 μF 10μF
Vo = 24 V Vo = 36 V Vo = 48 V	- - -	- - -	28V 40V 52V	
/	-	-	10%Vo	
	-	-	±2%	100%
	-	-	±3%	
	-	0.40 s	0.75 s	120Vac 75%~100%
	-	0.30 s	0.50 s	220Vac 75%~100%
	-	-	0.2%/°C	=0°C~Tc

@120Vac: Vo = 24 V Vo = 36 V Vo = 48 V	82% 83% 84%	83% 84% 85%	- - -	100% 25°C
@220Vac: Vo = 24 V Vo = 36 V Vo = 48 V	83% 84% 85%	84% 85% 86%	- - -	100% 25°C
	-	-	5 W	
	200,000 Hours	-	-	120Vac 25 80% (MIL-HDBK-217F)
	-	91,100 Hours	-	120Vac 80% 60
	-40 °C	-	+90 °C	
	-40 °C		+70 °C	10% RH to 90% RH
	-40 °C		+85 °C	5% RH to 95% RH

(L x W x H)	3.07 x 3.15 x 1.06			
(L x W x H)	78 x 80 x 27			
	-	220 g	-	

UL/CUL	UL8750, UL 1310, CAN/CSA-C22.2 No. 250.13, CAN/CSA-C22.2 No. 223-M91
CE	EN 61347-1, EN61347-2-13
BIS	IS 15885(Part2/Sec13)
EAC	61347-1, IEC 61347-2-13
KS	KS C 7655
EMI	
EN 55015/KN 15 ⁽¹⁾	Conducted emission Test & Radiated emission Test
EN 61000-3-2	Harmonic current emissions
EN 61000-3-3	Voltage fluctuations & flicker
FCC Part 15 ⁽¹⁾	ANSI C63.4 Class B This device complies with Part 15 of the FCC Rules. Operation is subject to the following two conditions: [1] this device may not cause harmful interference, and [2] this device must accept any interference received, including interference that may cause undesired operation.
EMS	
EN 61000-4-2	Electrostatic Discharge (ESD): 8 kV air discharge, 4 kV contact discharge
EN 61000-4-3	Radio-Frequency Electromagnetic Field Susceptibility Test-RS
EN 61000-4-4	Electrical Fast Transient / Burst-EFT
EN 61000-4-5	Surge Immunity Test: AC Power Line: Differential Mode 2 kV
EN 61000-4-6	Conducted Radio Frequency Disturbances Test-CS
EN 61000-4-8	Power Frequency Magnetic Field Test
EN 61000-4-11	Voltage Dips
EN 61547	Electromagnetic Immunity Requirements Applies To Lighting Equipment

1 EMI

() EMI

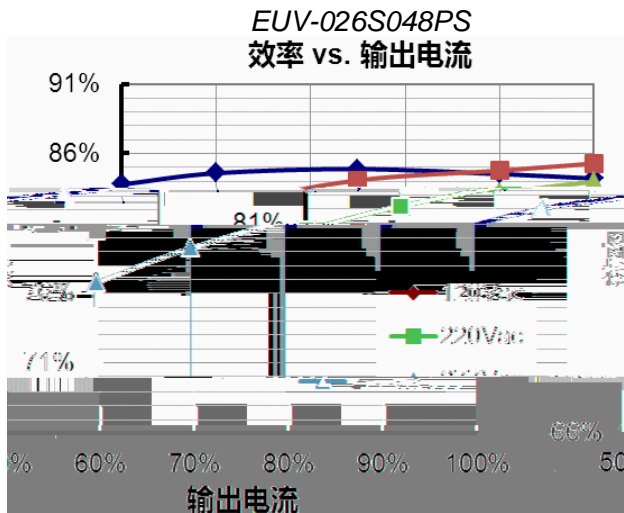
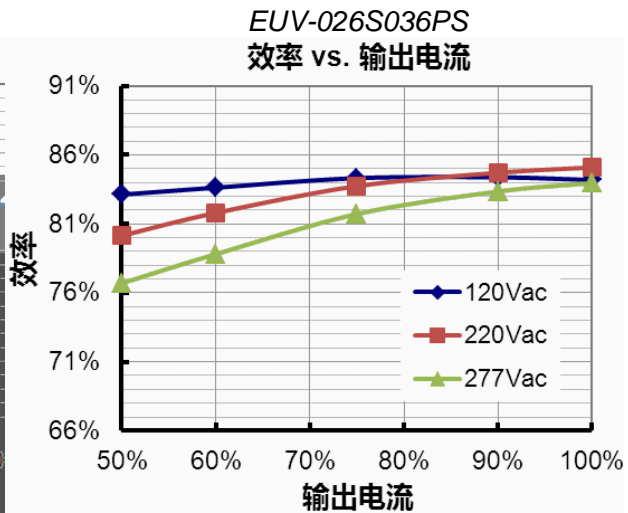
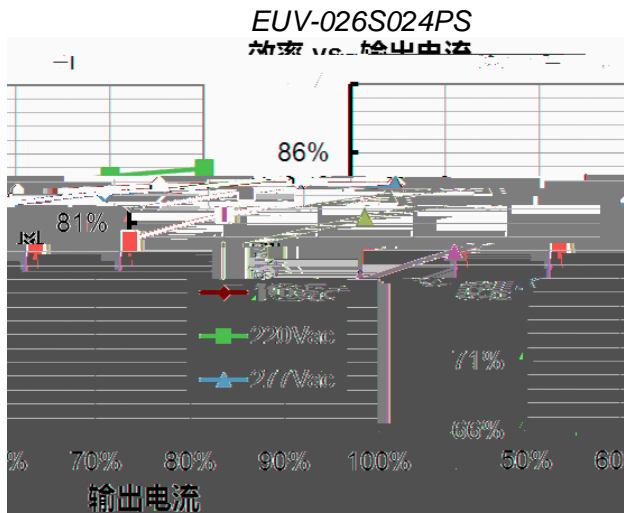
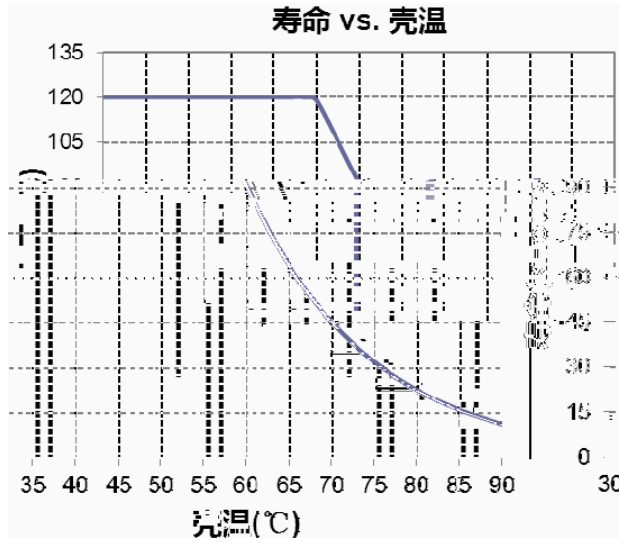

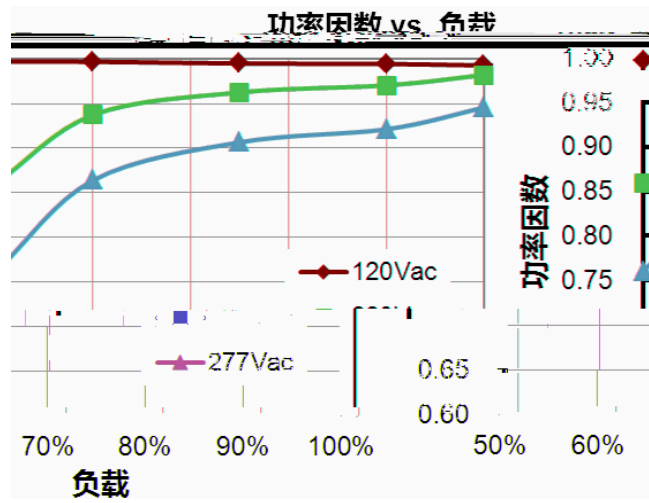

	110%	120%	130%	
	1.10Io	1.40Io	1.7Io	

EUV-026SxxxPS

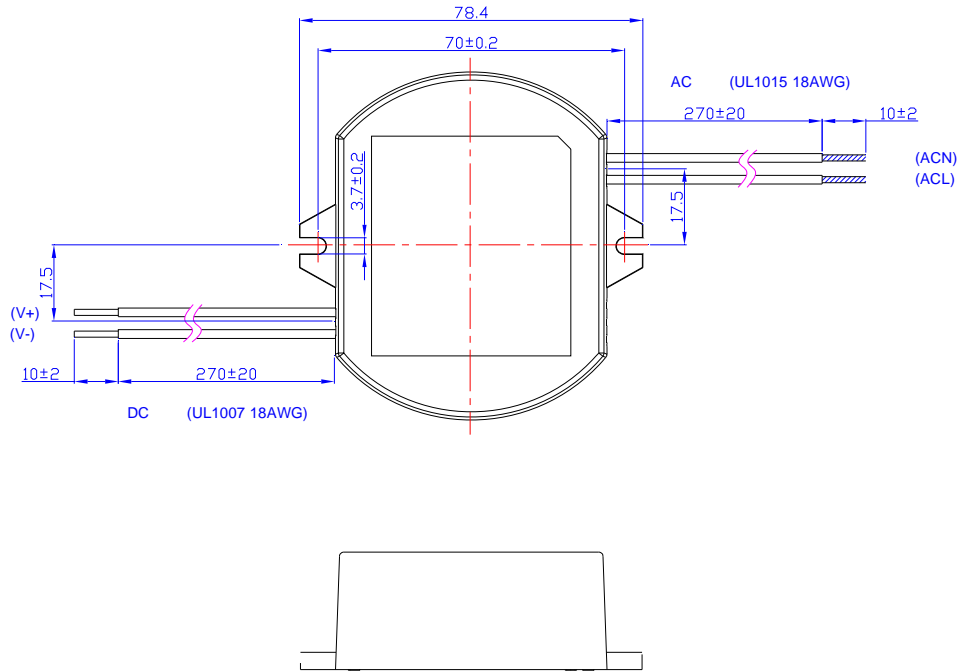

PROJ.

: ±1

EUV-026SxxxPS

Rev. K

= /6 5 8 « —

T_ 8 U . 9 L -

é [D } ... ` , (8 U . 9 6 X

+ ; C ě Â • “ Œ 6 X g + ; h

ož

Ò ÷ 4 i x ? d - 9 1 5 Š Đ Ò Z é Á ' š g p r i l f c Ø o ž

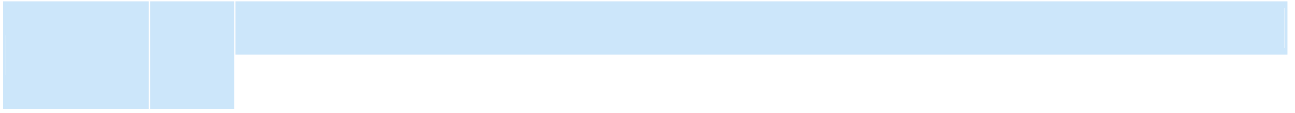

2019-08-14	J	RoHS	/	
2021-03-26	K		/	
		EAC	/	
		BIS	/	
			/	
		- 6 -00K0	/	
			/	
		- - BIS & EAC	/	
		- EUV-026SxxxPS-00K0	/	